

# LM4667 Boomer® Audio Power Amplifier Series

## Filterless High Efficiency 1.3W Switching Audio Amplifier

### General Description

The LM4667 is a fully integrated single-supply high efficiency switching audio amplifier. It features an innovative modulator that eliminates the LC output filter used with typical switching amplifiers. Eliminating the output filter reduces parts count, simplifies circuit design, and reduces board area. The LM4667 processes analog inputs with a delta-sigma modulation technique that lowers output noise and THD when compared to conventional pulse width modulators.

The LM4667 is designed to meet the demands of mobile phones and other portable communication devices. Operating on a single 3V supply, it is capable of driving 8Ω transducer loads at a continuous average output of 450mW with less than 1%THD+N. Its flexible power supply requirements allow operation from 2.7V to 5.5V.

The LM4667 has high efficiency with an 8Ω transducer load compared to a typical Class AB amplifier. With a 3V supply, the IC's efficiency for a 100mW power level is 74%, reaching 84% at 450mW output power.

The LM4667 features a low-power consumption shutdown mode. Shutdown may be enabled by driving the Shutdown pin to a logic low (GND).

The LM4667 has fixed selectable gain of either 6dB or 12dB. The LM4667 has short circuit protection against a short from the outputs to  $V_{DD}$ , GND, or across the outputs.

### Key Specifications

- Efficiency at 3V, 100mW into 8Ω transducer 74% (typ)
- Efficiency at 3V, 450mW into 8Ω transducer 84% (typ)
- Efficiency at 5V, 1W into 8Ω transducer 86% (typ)
- Total quiescent power supply current 3.5mA (typ)
- Total shutdown power supply current 0.01μA (typ)
- Single supply range 2.7V to 5.5V

### Features

- No output filter required for inductive transducers
- Selectable gain of 6dB or 12dB
- Very fast turn on time: 5ms (typ)
- Minimum external components
- "Click and pop" suppression circuitry
- Micro-power shutdown mode
- Short circuit protection
- Available in space-saving micro SMD and MSOP packages

### Applications

- Mobile phones
- PDAs
- Portable electronic devices

### Typical Application

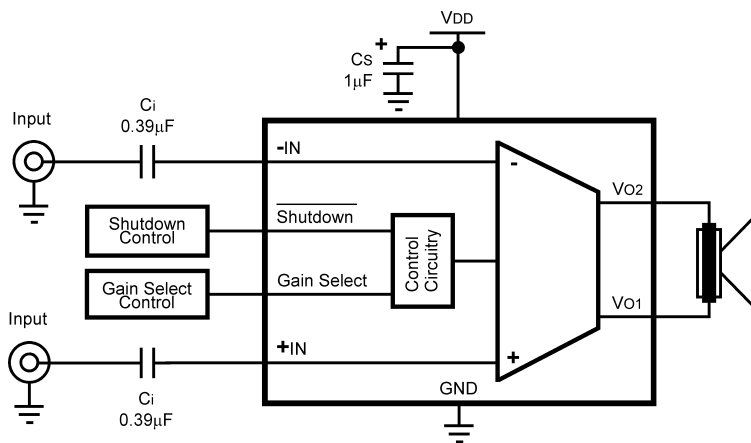
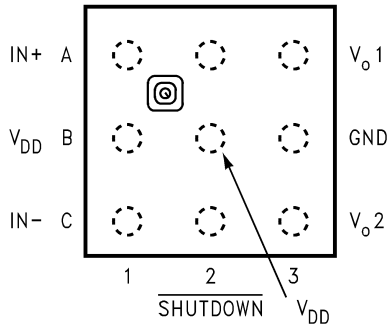

FIGURE 1. Typical Audio Amplifier Application Circuit

# Connection Diagrams

**9 Bump micro SMD Package**  
GAIN SELECT



20040536

**Top View**  
Order Number LM4667ITL, LM4667ITLX  
See NS Package Number TLA09AAA

**Mini Small Outline (MSOP) Package**

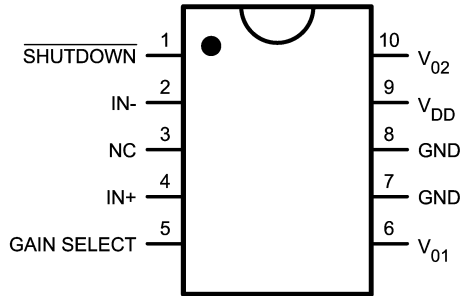

20040514

**Top View**  
Order Number LM4667MM  
See NS Package Number MUB10A

**micro SMD Marking**

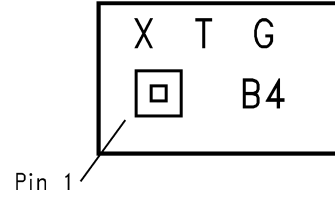

200405C6

**Top View**  
X — Date Code  
T — Die Traceability  
G — Boomer Family  
B4 — LM4667ITL

**MSOP Marking**

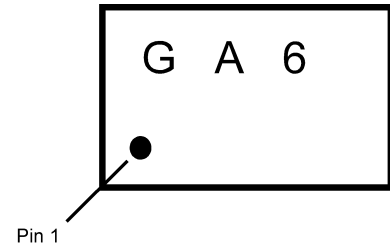

200405H8

**Top View**  
G — Boomer Family  
A6 — LM4667MM

**Absolute Maximum Ratings** (Notes 1, 2)

If Military/Aerospace specified devices are required, please contact the National Semiconductor Sales Office/Distributors for availability and specifications.

Supply Voltage (Note1)	6.0V
Storage Temperature	-65°C to +150°C
Voltage at Any Input Pin	$V_{DD} + 0.3V \geq V \geq GND - 0.3V$
Power Dissipation (Note 3)	Internally Limited
ESD Susceptibility (Note 4)	7.0kV
ESD Susceptibility (Note 5)	250V
Junction Temperature ( $T_J$ )	150°C
Thermal Resistance	

$\theta_{JA}$ (micro SMD)	220°C/W
$\theta_{JA}$ (MSOP)	190°C/W
$\theta_{JC}$ (MSOP)	56°C/W

**Soldering Information**

See AN-1112 "microSMD Wafers Level Chip Scale Package."

**Operating Ratings** (Note 2)

Temperature Range	$-40^\circ\text{C} \leq T_A \leq 85^\circ\text{C}$
Supply Voltage	$2.7V \leq V_{DD} \leq 5.5V$

**Electrical Characteristics  $V_{DD} = 5V$**  (Notes 1, 2)

The following specifications apply for  $V_{DD} = 5V$  and  $R_L = 15\mu\text{H} + 8\Omega + 15\mu\text{H}$  unless otherwise specified. Limits apply for  $T_A = 25^\circ\text{C}$ .

Symbol	Parameter	Conditions	LM4667		Units (Limits)
			Typical	Limit	
			(Note 6)	(Notes 7, 8)	
$I_{DD}$	Quiescent Power Supply Current	$V_{IN} = 0V$ , No Load	8		mA
		$V_{IN} = 0V$ , $R_L = 15\mu\text{H} + 8\Omega + 15\mu\text{H}$	9		mA
$I_{SD}$	Shutdown Current	$V_{SD} = GND$ (Note 9)	0.01		$\mu\text{A}$
$V_{SDIH}$	Shutdown Voltage Input High		1.2		V
$V_{SDIL}$	Shutdown Voltage Input Low		1.1		V
$V_{GSIH}$	Gain Select Input High		1.2		V
$V_{GSIL}$	Gain Select Input Low		1.1		V
$A_V$	Closed Loop Gain	$V_{Gain\ Select} = V_{DD}$	6		dB
$A_V$	Closed Loop Gain	$V_{Gain\ Select} = GND$	12		dB
$V_{OS}$	Output Offset Voltage		10		mV
$T_{WU}$	Wake-up Time		5		ms
$P_o$	Output Power	THD = 2% (max), $f = 1\text{kHz}$	1.3		W
THD+N	Total Harmonic Distortion+Noise	$P_O = 100\text{mW}_{RMS}$ ; $f_{IN} = 1\text{kHz}$	0.8		%
$R_{IN}$	Differential Input Resistance	$V_{Gain\ Select} = V_{DD}$	90		$\text{k}\Omega$
		$V_{Gain\ Select} = GND$	60		$\text{k}\Omega$
PSRR	Power Supply Rejection Ratio	$V_{Ripple} = 100\text{mV}_{RMS}$ sine wave Inputs terminated to GND	55 ( $f = 217\text{Hz}$ )		dB
		$V_{Ripple} = 100\text{mV}_{RMS}$ sine wave $P_{OUT} = 10\text{mW}$ , $1\text{kHz}$	65 ( $f = 217\text{Hz}$ )		dB
CMRR	Common Mode Rejection Ratio	$V_{Ripple} = 100\text{mV}_{RMS}$ , $f_{Ripple} = 217\text{Hz}$	41		dB
SNR	Signal to Noise Ratio	$P_O = 1\text{W}_{RMS}$ ; A-Weighted Filter	83		dB
$\epsilon_{OUT}$	Output Noise	A-Weighted filter, $V_{in} = 0V$	200		$\mu\text{V}$

## Electrical Characteristics $V_{DD} = 3V$ (Notes 1, 2)

The following specifications apply for  $V_{DD} = 3V$  and  $R_L = 15\mu H + 8\Omega + 15\mu H$  unless otherwise specified. Limits apply for  $T_A = 25^\circ C$ .

Symbol	Parameter	Conditions	LM4667		Units (Limits)
			Typical	Limit	
			(Note 6)	(Notes 7, 8)	
$I_{DD}$	Quiescent Power Supply Current	$V_{IN} = 0V$ , No Load $V_{IN} = 0V$ , $R_L = 15\mu H + 8\Omega + 15\mu H$	3.50 3.75	5.0	mA (max)
$I_{SD}$	Shutdown Current	$V_{SD} = GND$ (Note 9)	0.01	2.0	$\mu A$ (max)
$V_{SDIH}$	Shutdown Voltage Input High		1.0	1.4	V (min)
$V_{SDIL}$	Shutdown Voltage Input Low		0.8	0.4	V (max)
$V_{GSIH}$	Gain Select Input High		1.0	1.4	V (min)
$V_{GSIL}$	Gain Select Input Low		0.8	0.4	V (max)
$A_V$	Closed Loop Gain	$V_{Gain\ Select} = V_{DD}$	6	5.5 6.5	dB (min) dB (max)
$A_V$	Closed Loop Gain	$V_{Gain\ Select} = GND$	12	11.5 12.5	dB (min) dB (max)
$V_{OS}$	Output Offset Voltage		10	25	mV (max)
$T_{WU}$	Wake-up Time		5		ms
$P_O$	Output Power	THD = 1% (max); $f = 1kHz$	450	425	mW (min)
THD+N	Total Harmonic Distortion+Noise	$P_O = 100mW_{RMS}$ ; $f_{IN} = 1kHz$	0.35		%
$R_{IN}$	Differential Input Resistance	$V_{Gain\ Select} = V_{DD}$ $V_{Gain\ Select} = GND$	90 60		k $\Omega$ k $\Omega$
PSRR	Power Supply Rejection Ratio	$V_{ripple} = 100mV_{RMS}$ sine wave Inputs terminated to GND	56 ( $f = 217Hz$ )		dB
		$V_{Ripple} = 100mV_{RMS}$ sine wave $P_{OUT} = 10mW, 1kHz$	65 ( $f = 217Hz$ )		dB
CMRR	Common Mode Rejection Ratio	$V_{Ripple} = 100mV_{RMS}$ , $f_{Ripple} = 217Hz$	41		dB
SNR	Signal to Noise Ratio	$P_O = 400mW_{RMS}$ , A-Weighted Filter	83		dB
$\epsilon_{OUT}$	Output Noise	A-Weighted filter, $V_{in} = 0V$	125		$\mu V$

**Note 1:** All voltages are measured with respect to the ground pin, unless otherwise specified.

**Note 2:** *Absolute Maximum Ratings* indicate limits beyond which damage to the device may occur. *Operating Ratings* indicate conditions for which the device is functional, but do not guarantee specific performance limits. *Electrical Characteristics* state DC and AC electrical specifications under particular test conditions which guarantee specific performance limits. This assumes that the device is within the Operating Ratings. Specifications are not guaranteed for parameters where no limit is given, however, the typical value is a good indication of device performance.

**Note 3:** The maximum power dissipation must be derated at elevated temperatures and is dictated by  $T_{JMAX}$ ,  $\theta_{JA}$ , and the ambient temperature  $T_A$ . The maximum allowable power dissipation is  $P_{DMAX} = (T_{JMAX} - T_A) / \theta_{JA}$  or the number given in Absolute Maximum Ratings, whichever is lower. For the LM4667,  $T_{JMAX} = 150^\circ C$ . The typical  $\theta_{JA}$  is  $220^\circ C/W$  for the microSMD package and  $190^\circ C/W$  for the MSOP package.

**Note 4:** Human body model, 100pF discharged through a 1.5k $\Omega$  resistor.

**Note 5:** Machine Model, 220pF–240pF discharged through all pins.

**Note 6:** Typical specifications are specified at  $25^\circ C$  and represent the parametric norm.

**Note 7:** Tested limits are guaranteed to National's AOQL (Average Outgoing Quality Level).

**Note 8:** Datasheet min/max specification limits are guaranteed by design, test, or statistical analysis.

**Note 9:** Shutdown current is measured in a normal room environment. Exposure to direct sunlight will increase  $I_{SD}$  by a maximum of 2 $\mu A$ . The Shutdown pin should be driven as close as possible to GND for minimal shutdown current and to  $V_{DD}$  for the best THD performance in PLAY mode. See the **Application Information** section under SHUTDOWN FUNCTION for more information.

## External Components Description

(Figure 1)

Components	Functional Description
1. $C_S$	Supply bypass capacitor which provides power supply filtering. Refer to the <b>Power Supply Bypassing</b> section for information concerning proper placement and selection of the supply bypass capacitor.
2. $C_I$	Input AC coupling capacitor which blocks the DC voltage at the amplifier's input terminals.

# Typical Performance Characteristics

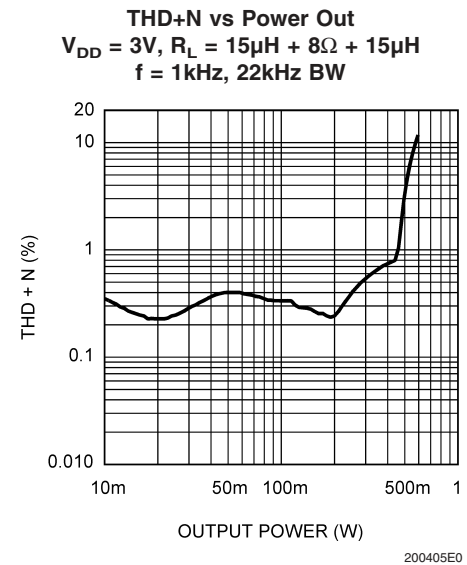
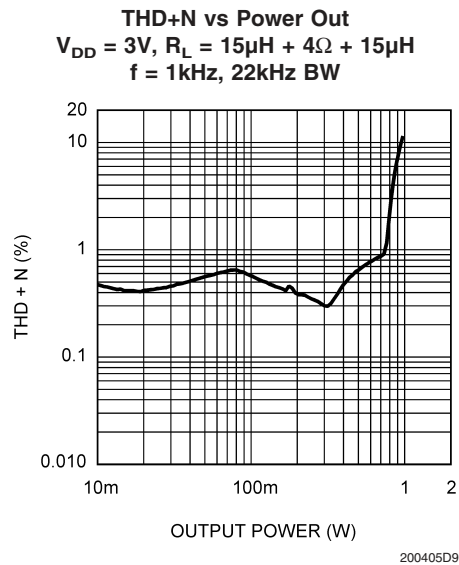
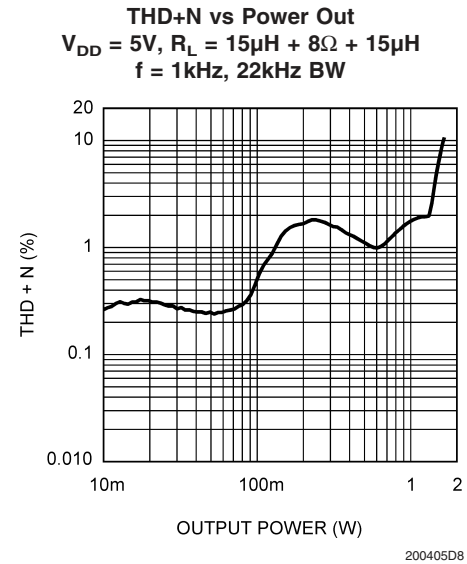
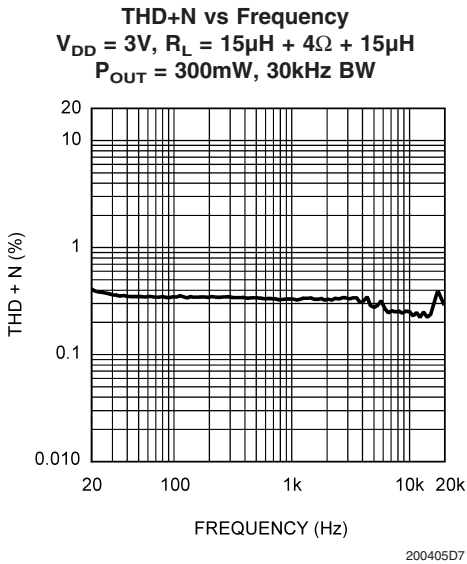
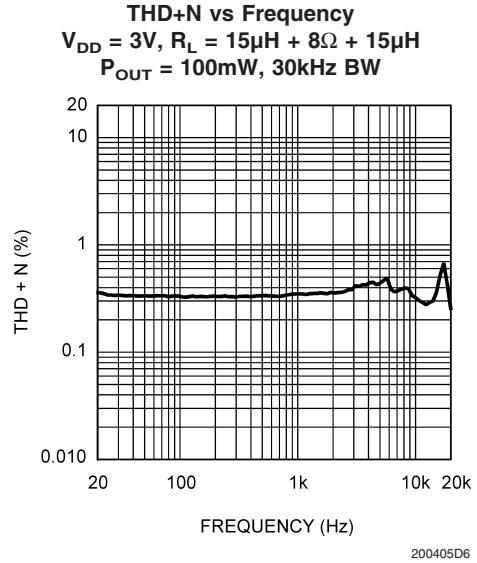
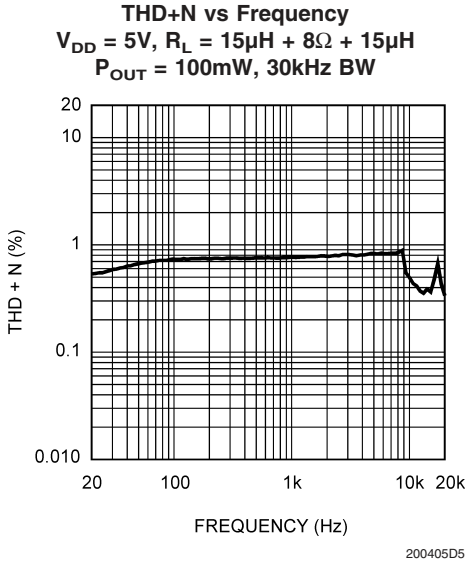

Typical Performance Characteristics (Continued)

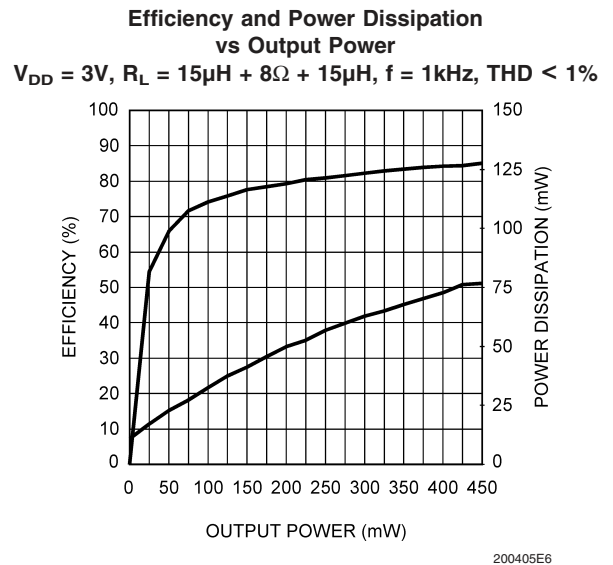
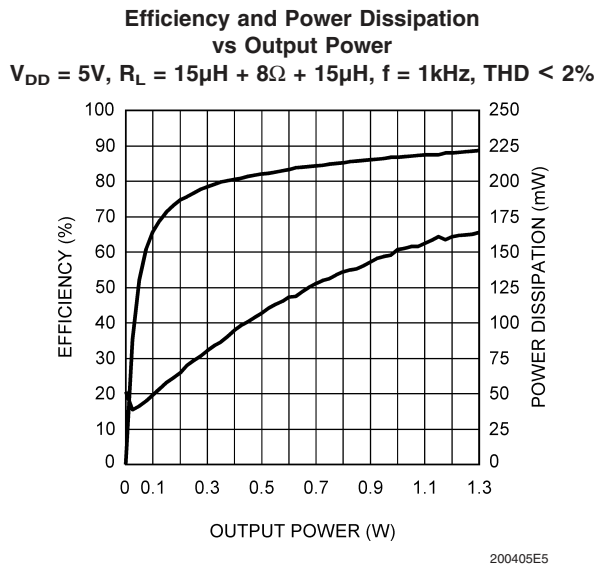
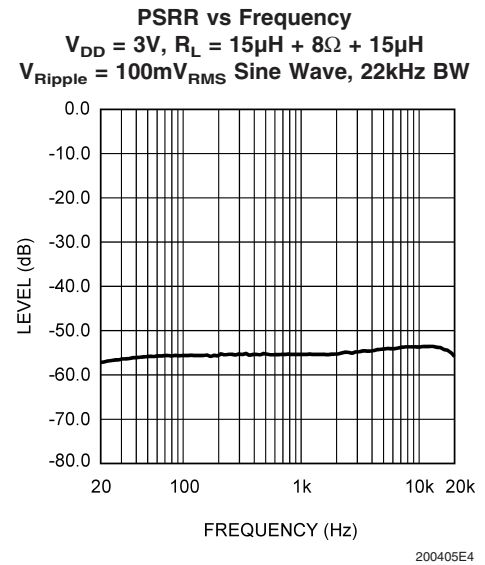
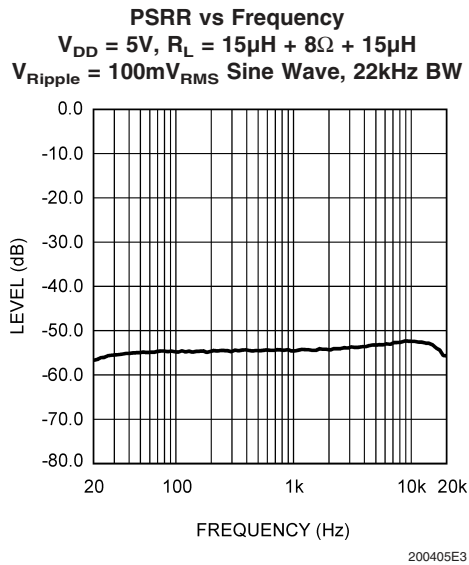
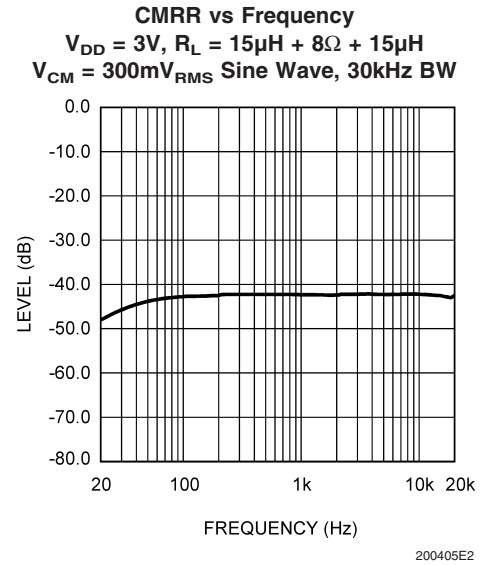
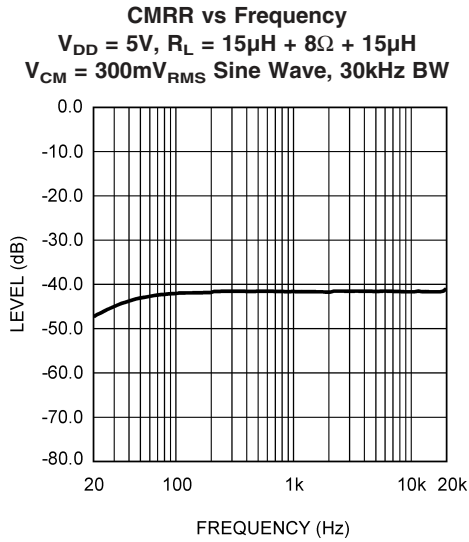

# Typical Performance Characteristics (Continued)

**Efficiency and Power Dissipation vs Output Power**

$V_{DD} = 3V$ ,  $R_L = 15\mu H + 4\Omega + 15\mu H$ ,  $f = 1kHz$ ,  $THD < 1\%$

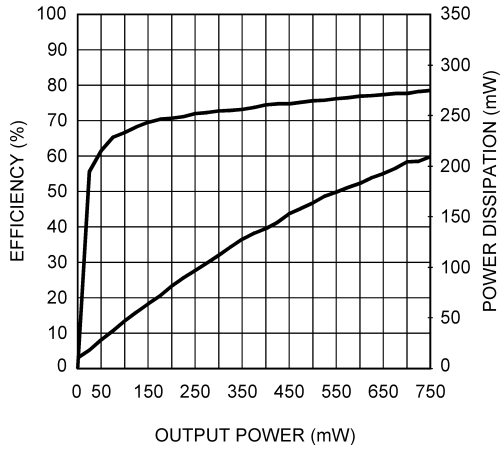

200405E7

**Gain Select Threshold**

$V_{DD} = 3V$

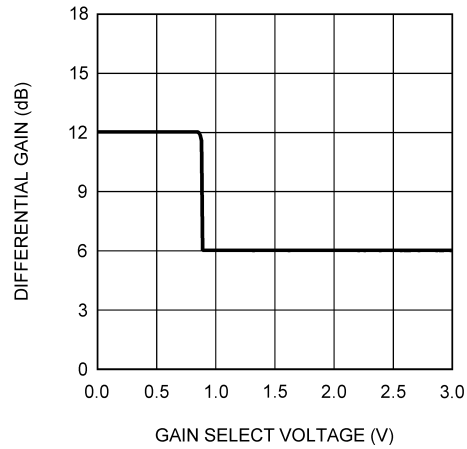

200405H6

**Gain Select Threshold**

$V_{DD} = 5V$

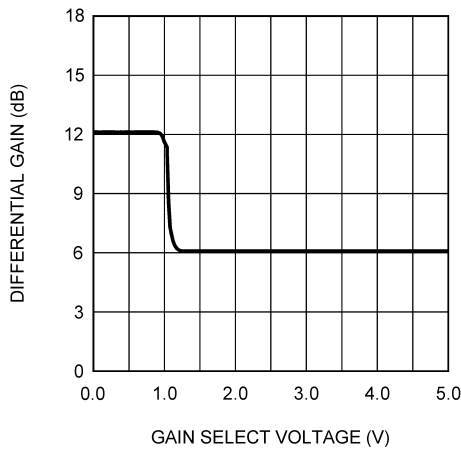

200405H1

**Gain Select Threshold vs Supply Voltage**

$R_L = 15\mu H + 8\Omega + 15\mu H$

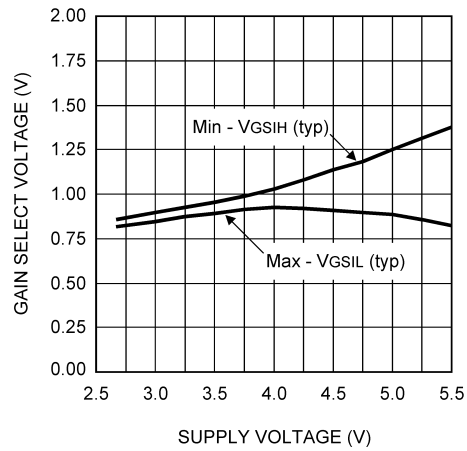

200405H2

**Output Power vs Supply Voltage**

$R_L = 15\mu H + 4\Omega + 15\mu H$ ,  $f = 1kHz$

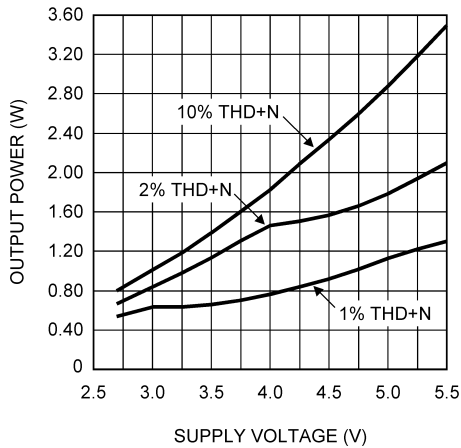

200405F3

**Output Power vs Supply Voltage**

$R_L = 15\mu H + 8\Omega + 15\mu H$ ,  $f = 1kHz$

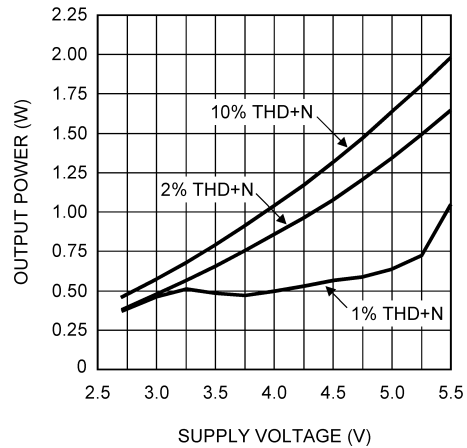

200405F4

Typical Performance Characteristics (Continued)

**Output Power vs Supply Voltage**  
 $R_L = 15\mu H + 16\Omega + 15\mu H, f = 1kHz$

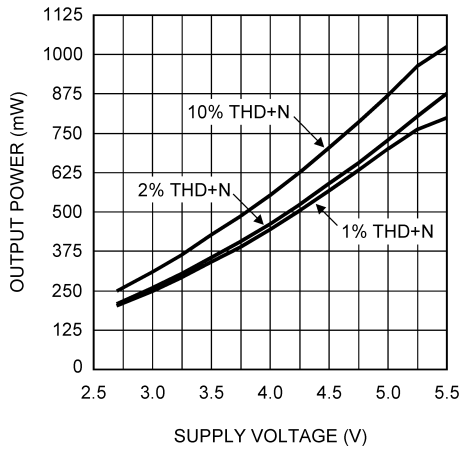

200405F5

**Shutdown Threshold**  
 $V_{DD} = 5V$

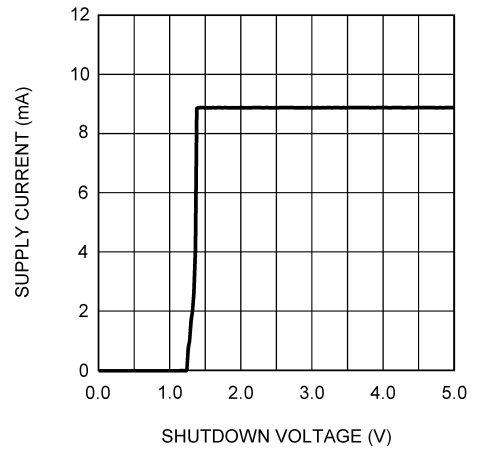

200405H4

**Shutdown Threshold**  
 $V_{DD} = 3V$

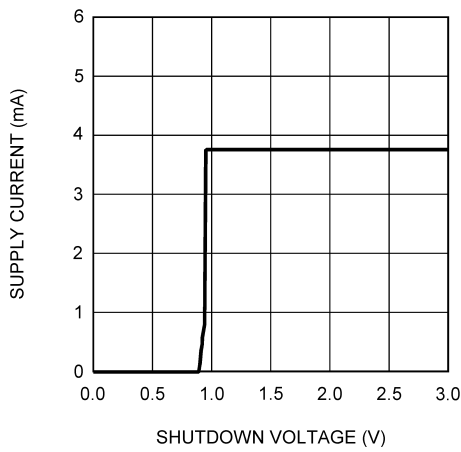

200405H3

**Shutdown Threshold vs Supply Voltage**  
 $R_L = 15\mu H + 8\Omega + 15\mu H$

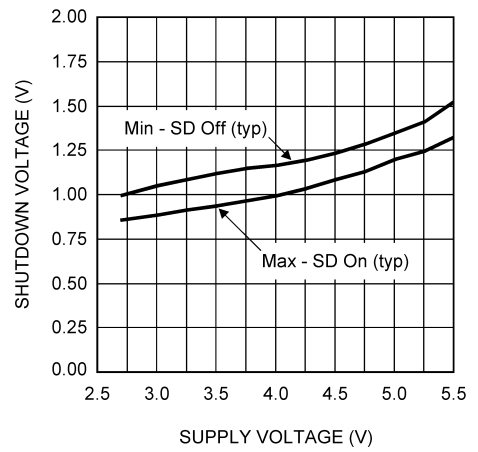

200405H5

**Supply Current vs Shutdown Voltage**  
 $R_L = 15\mu H + 8\Omega + 15\mu H$

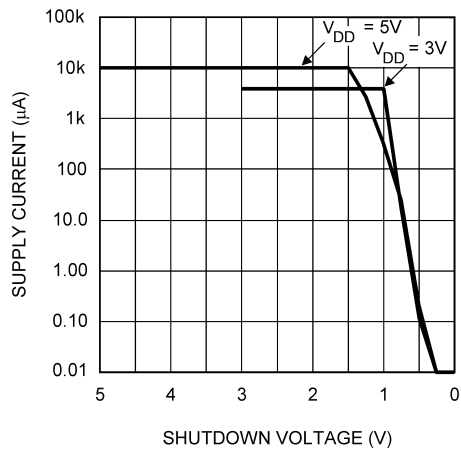

200405H0

**Supply Current vs Supply Voltage**  
 $R_L = 15\mu H + 8\Omega + 15\mu H$

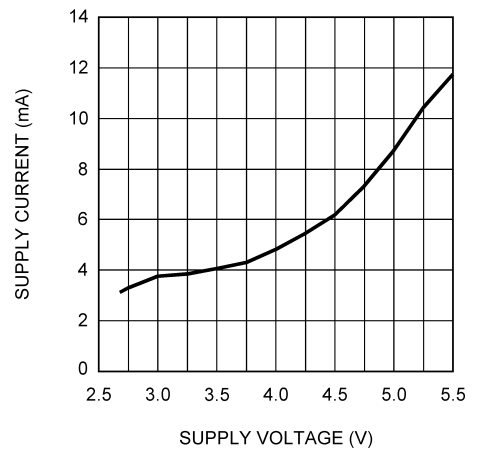

200405G0



## Application Information

### GENERAL AMPLIFIER FUNCTION

The output signals generated by the LM4667 consist of two, BTL connected, output signals that pulse momentarily from near ground potential to  $V_{DD}$ . The two outputs can pulse independently with the exception that they both may never pulse simultaneously as this would result in zero volts across the BTL load. The minimum width of each pulse is approximately 160ns. However, pulses on the same output can occur sequentially, in which case they are concatenated and appear as a single wider pulse to achieve an effective 100% duty cycle. This results in maximum audio output power for a given supply voltage and load impedance. The LM4667 can achieve much higher efficiencies than class AB amplifiers while maintaining acceptable THD performance.

The short (160ns) drive pulses emitted at the LM4667 outputs means that good efficiency can be obtained with minimal load inductance. The typical transducer load on an audio amplifier is quite reactive (inductive). For this reason, the load can act as it's own filter, so to speak. This "filter-less" switching amplifier/transducer load combination is much more attractive economically due to savings in board space and external component cost by eliminating the need for a filter.

### POWER DISSIPATION AND EFFICIENCY

In general terms, efficiency is considered to be the ratio of useful work output divided by the total energy required to produce it with the difference being the power dissipated, typically, in the IC. The key here is "useful" work. For audio systems, the energy delivered in the audible bands is considered useful including the distortion products of the input signal. Sub-sonic (DC) and super-sonic components (>22kHz) are not useful. The difference between the power flowing from the power supply and the audio band power being transduced is dissipated in the LM4667 and in the transducer load. The amount of power dissipation in the LM4667 is very low. This is because the ON resistance of the switches used to form the output waveforms is typically less than  $0.25\Omega$ . This leaves only the transducer load as a potential "sink" for the small excess of input power over audio band output power. The LM4667 dissipates only a fraction of the excess power requiring no additional PCB area or cop-plane to act as a heat sink.

### DIFFERENTIAL AMPLIFIER EXPLANATION

As logic supply voltages continue to shrink, designers are increasingly turning to differential analog signal handling to preserve signal to noise ratios with restricted voltage swing. The LM4667 is a fully differential amplifier that features differential input and output stages. A differential amplifier amplifies the difference between the two input signals. Traditional audio power amplifiers have typically offered only single-ended inputs resulting in a 6dB reduction in signal to noise ratio relative to differential inputs. The LM4667 also offers the possibility of DC input coupling which eliminates the two external AC coupling, DC blocking capacitors. The LM4667 can be used, however, as a single ended input amplifier while still retaining it's fully differential benefits. In fact, completely unrelated signals may be placed on the input pins. The LM4667 simply amplifies the difference between the signals. A major benefit of a differential amplifier is the improved common mode rejection ratio (CMRR) over

single input amplifiers. The common-mode rejection characteristic of the differential amplifier reduces sensitivity to ground offset related noise injection, especially important in high noise applications.

### PCB LAYOUT CONSIDERATIONS

As output power increases, interconnect resistance (PCB traces and wires) between the amplifier, load and power supply create a voltage drop. The voltage loss on the traces between the LM4667 and the load results in lower output power and decreased efficiency. Higher trace resistance between the supply and the LM4667 has the same effect as a poorly regulated supply, increase ripple on the supply line also reducing the peak output power. The effects of residual trace resistance increases as output current increases due to higher output power, decreased load impedance or both. To maintain the highest output voltage swing and corresponding peak output power, the PCB traces that connect the output pins to the load and the supply pins to the power supply should be as wide as possible to minimize trace resistance.

The rising and falling edges are necessarily short in relation to the minimum pulse width (160ns), having approximately 2ns rise and fall times, typical, depending on parasitic output capacitance. The inductive nature of the transducer load can also result in overshoot on one or both edges, clamped by the parasitic diodes to GND and  $V_{DD}$  in each case. From an EMI standpoint, this is an aggressive waveform that can radiate or conduct to other components in the system and cause interference. It is essential to keep the power and output traces short and well shielded if possible. Use of ground planes, beads, and micro-strip layout techniques are all useful in preventing unwanted interference.

### POWER SUPPLY BYPASSING

As with any power amplifier, proper supply bypassing is critical for low noise performance and high power supply rejection ratio (PSRR). The capacitor ( $C_S$ ) location should be as close as possible to the LM4667. Typical applications employ a voltage regulator with a  $10\mu\text{F}$  and a  $0.1\mu\text{F}$  bypass capacitors that increase supply stability. These capacitors do not eliminate the need for bypassing on the supply pin of the LM4667. A  $1\mu\text{F}$  tantalum capacitor is recommended.

### SHUTDOWN FUNCTION

In order to reduce power consumption while not in use, the LM4667 contains shutdown circuitry that reduces current draw to less than  $0.01\mu\text{A}$ . The trigger point for shutdown is shown as a typical value in the Electrical Characteristics Tables and in the Shutdown Hysteresis Voltage graphs found in the **Typical Performance Characteristics** section. It is best to switch between ground and supply for minimum current usage while in the shutdown state. While the LM4667 may be disabled with shutdown voltages in between ground and supply, the idle current will be greater than the typical  $0.01\mu\text{A}$  value. Increased THD may also be observed with voltages less than  $V_{DD}$  on the Shutdown pin when in PLAY mode.

The LM4667 has an internal resistor connected between GND and Shutdown pins. The purpose of this resistor is to eliminate any unwanted state changes when the Shutdown pin is floating. The LM4667 will enter the shutdown state when the Shutdown pin is left floating or if not floating, when

## Application Information (Continued)

the shutdown voltage has crossed the threshold. To minimize the supply current while in the shutdown state, the Shutdown pin should be driven to GND or left floating. If the Shutdown pin is not driven to GND, the amount of additional resistor current due to the internal shutdown resistor can be found by Equation (1) below.

$$(V_{SD} - GND) / 60k\Omega \quad (1)$$

With only a 0.5V difference, an additional 8.3 $\mu$ A of current will be drawn while in the shutdown state.

### GAIN SELECTION FUNCTION

The LM4667 has fixed selectable gain to minimize external components, increase flexibility and simplify design. For a differential gain of 6dB, the Gain Select pin should be per-

manently connected to  $V_{DD}$  or driven to a logic high level. For a differential gain of 12dB, the Gain Select pin should be permanently connected to GND or driven to a logic low level. The gain of the LM4667 can be switched while the amplifier is in PLAY mode driving a load with a signal without damage to the IC. The voltage on the Gain Select pin should be switched quickly between GND (logic low) and  $V_{DD}$  (logic high) to eliminate any possible audible artifacts from appearing at the output. For typical threshold voltages for the Gain Select function, refer to the Gain Threshold Voltages graph in the **Typical Performance Characteristics** section.

# Application Information (Continued)

## SINGLE-ENDED CIRCUIT CONFIGURATIONS

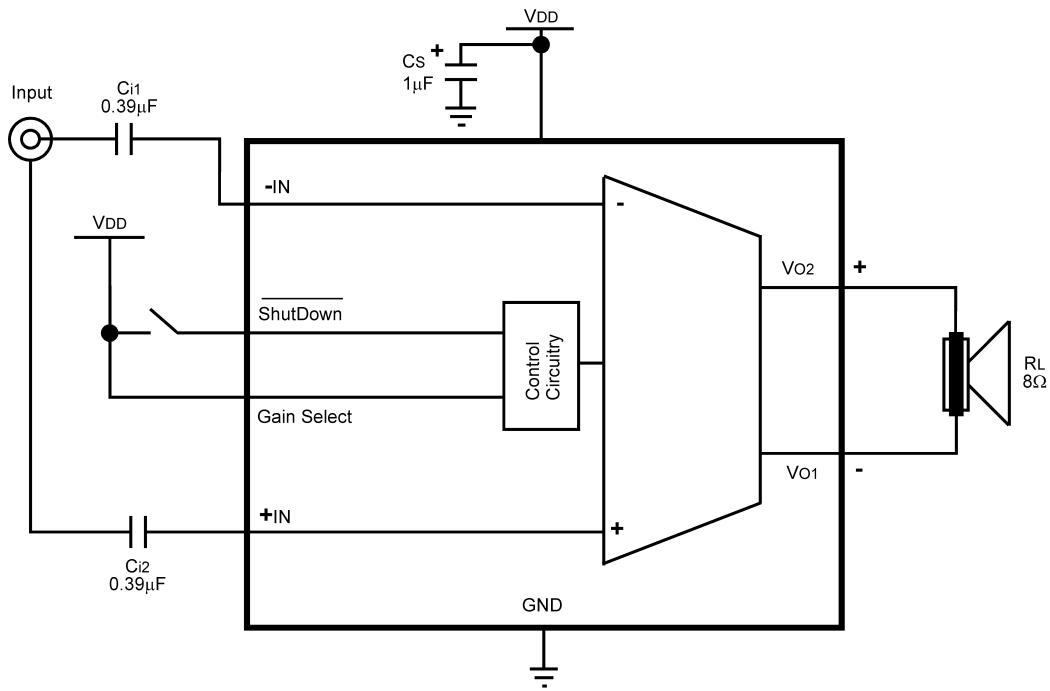

200405C8

FIGURE 2. Single-Ended Input with low gain selection configuration

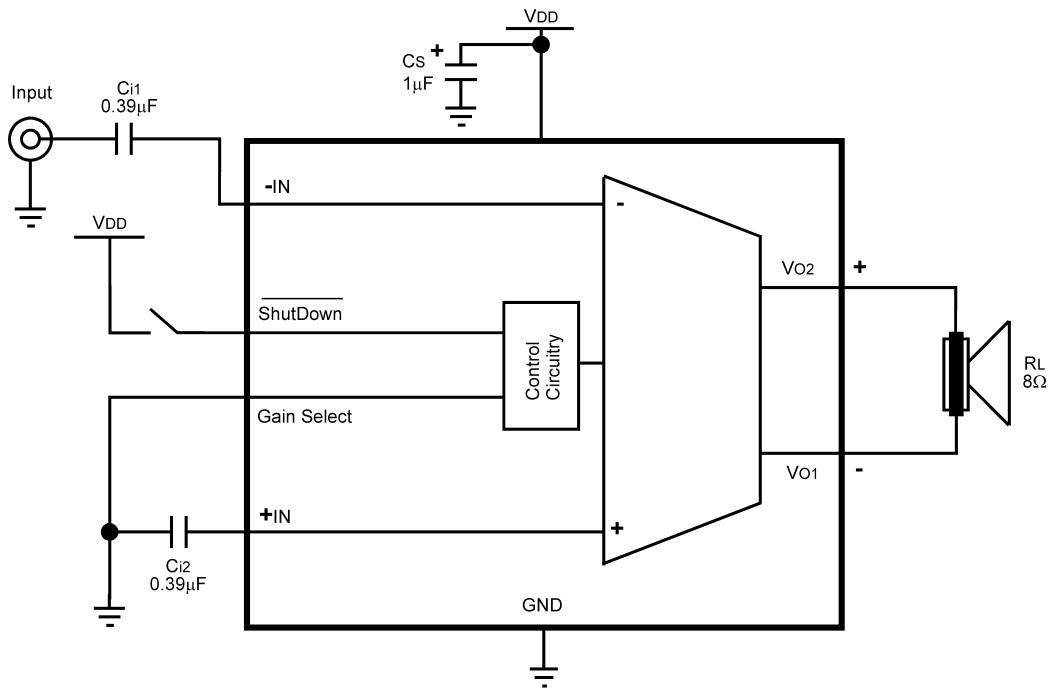

200405C9

FIGURE 3. Single-Ended Input with high gain selection configuration

## Application Information (Continued)

## REFERENCE DESIGN BOARD SCHEMATIC

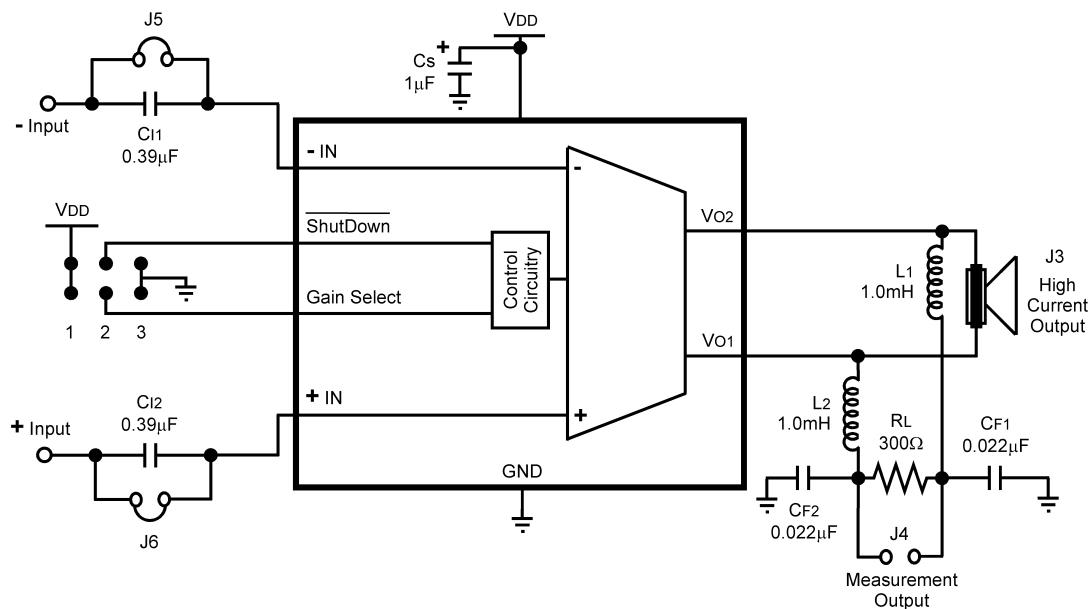

200405C7

FIGURE 4.

In addition to the minimal parts required for the application circuit, a measurement filter is provided on the evaluation circuit board so that conventional audio measurements can be conveniently made without additional equipment. This is a balanced input / grounded differential output low pass filter with a 3dB frequency of approximately 35kHz and an on board termination resistor of 300Ω (see schematic). Note that the capacitive load elements are returned to ground. This is not optimal for common mode rejection purposes, but due to the independent pulse format at each output there is a significant amount of high frequency common mode component on the outputs. The grounded capacitive filter elements attenuate this component at the board to reduce the high frequency CMRR requirement placed on the analysis instruments.

Even with the grounded filter the audio signal is still differential, necessitating a differential input on any analysis instrument connected to it. Most lab instruments that feature BNC connectors on their inputs are **NOT** differential responding because the ring of the BNC is usually grounded.

The commonly used Audio Precision analyzer is differential, but its ability to accurately reject fast pulses of 160nS width is questionable necessitating the on board measurement filter. When in doubt or when the signal needs to be single-ended, use an audio signal transformer to convert the differential output to a single ended output. Depending on the audio transformer's characteristics, there may be some attenuation of the audio signal which needs to be taken into account for correct measurement of performance.

Measurements made at the output of the measurement filter suffer attenuation relative to the primary, unfiltered outputs even at audio frequencies. This is due to the resistance of the inductors interacting with the termination resistor (300Ω) and is typically about -0.35dB (4%). In other words, the voltage levels (and corresponding power levels) indicated through the measurement filter are slightly lower than those that actually occur at the load placed on the unfiltered outputs. This small loss in the filter for measurement gives a lower output power reading than what is really occurring on the unfiltered outputs and its load.

# Application Information (Continued)

## LM4667 micro SMD BOARD ARTWORK

Composite View

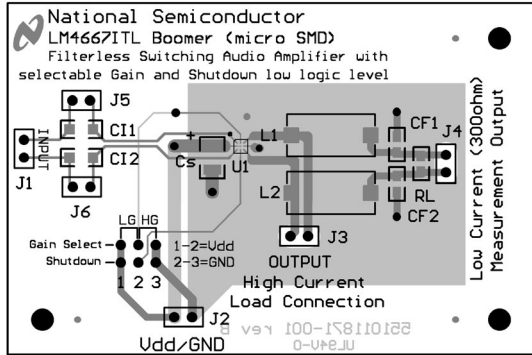

200405G7

Silk Screen

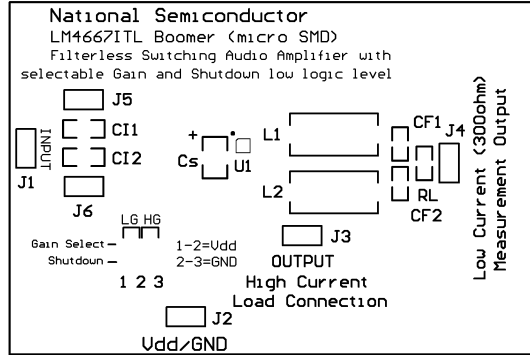

200405G6

Top Layer

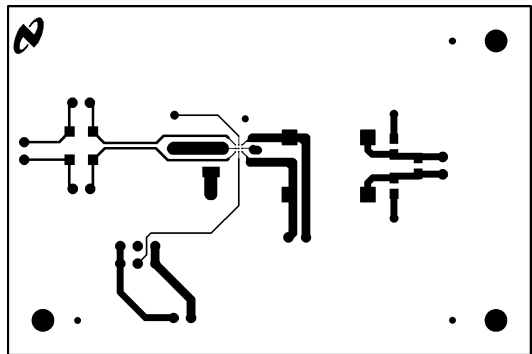

200405D1

Bottom Layer

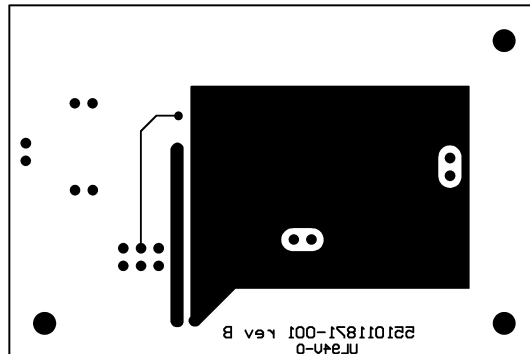

200405G8

# Application Information (Continued)

## LM4667 MSOP BOARD ARTWORK

Composite View

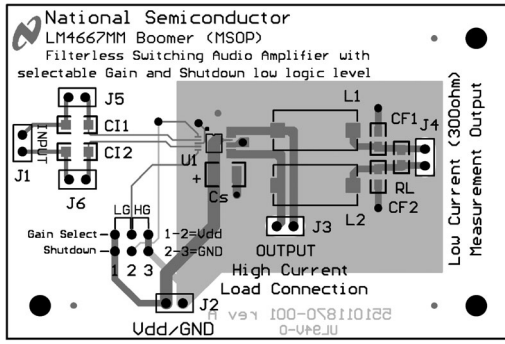

Silk Screen

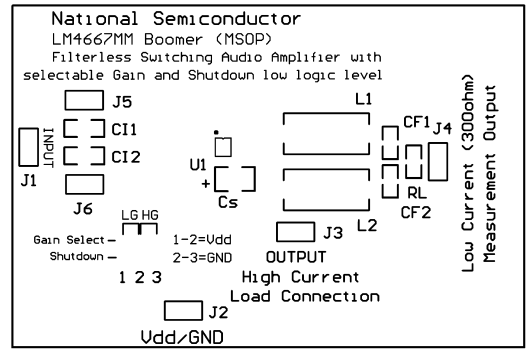

Top Layer

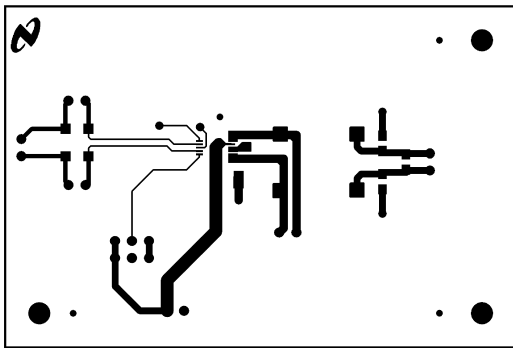

Bottom Layer

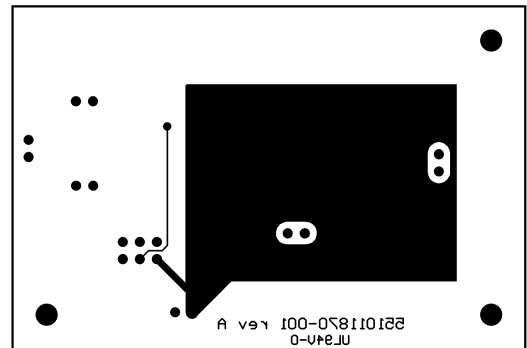

**Physical Dimensions** inches (millimeters) unless otherwise noted

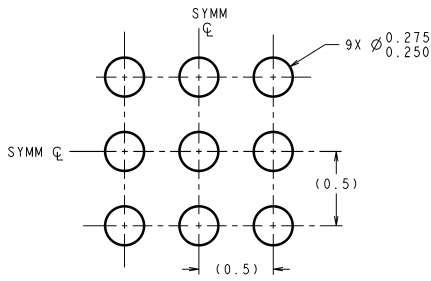

DIMENSIONS ARE IN MILLIMETERS  
DIMENSIONS IN ( ) FOR REFERENCE ONLY

**LAND PATTERN RECOMMENDATION**

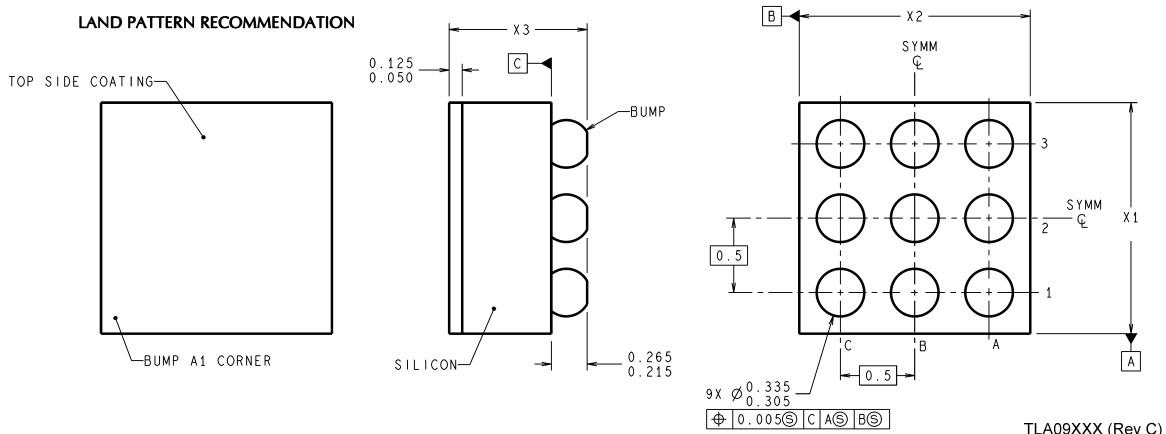

TLA09XXX (Rev C)

**9 Bump micro SMD**  
**Order Number LM4667ITL, LM4667ITLX**  
**NS Package Number TLA09AAA**  
**X1 = 1.514 X2 = 1.514 X3 = 0.600**

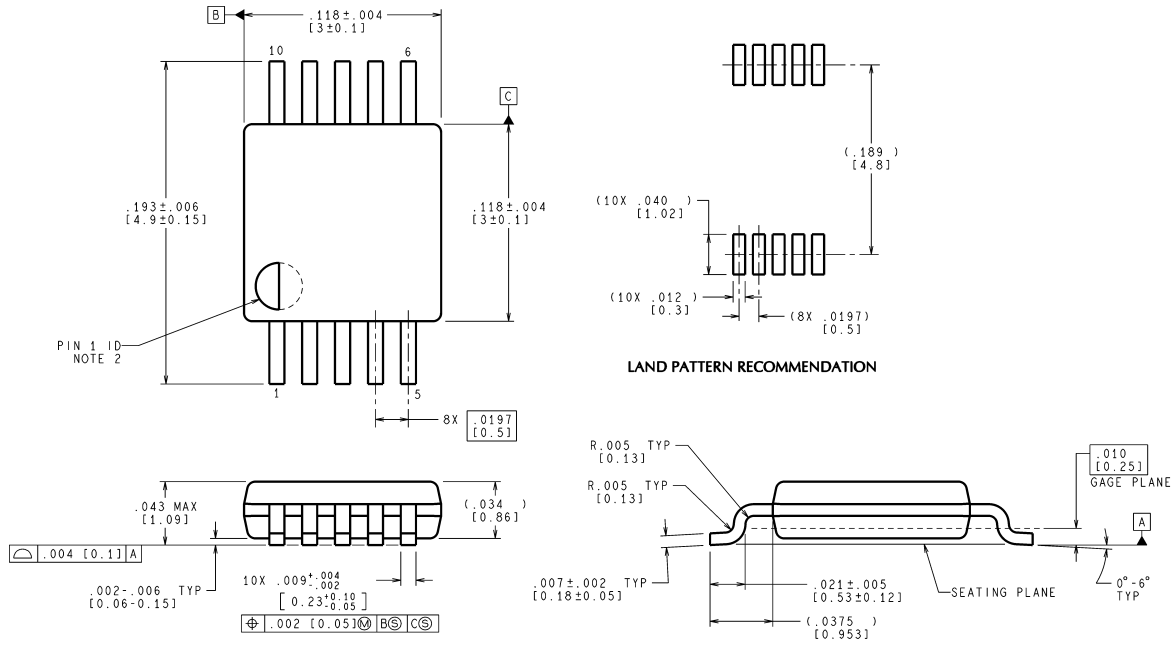

CONTROLLING DIMENSION IS INCH  
 VALUES IN [ ] ARE MILLIMETERS  
 DIMENSIONS IN ( ) FOR REFERENCE ONLY

MUB10A (Rev B)

**Mini Small Outline (MSOP)**  
**Order Number LM4667MM**  
**NS Package Number MUB10A**

## Notes

### LIFE SUPPORT POLICY

NATIONAL'S PRODUCTS ARE NOT AUTHORIZED FOR USE AS CRITICAL COMPONENTS IN LIFE SUPPORT DEVICES OR SYSTEMS WITHOUT THE EXPRESS WRITTEN APPROVAL OF THE PRESIDENT AND GENERAL COUNSEL OF NATIONAL SEMICONDUCTOR CORPORATION. As used herein:

1. Life support devices or systems are devices or systems which, (a) are intended for surgical implant into the body, or (b) support or sustain life, and whose failure to perform when properly used in accordance with instructions for use provided in the labeling, can be reasonably expected to result in a significant injury to the user.
2. A critical component is any component of a life support device or system whose failure to perform can be reasonably expected to cause the failure of the life support device or system, or to affect its safety or effectiveness.

### BANNED SUBSTANCE COMPLIANCE

National Semiconductor certifies that the products and packing materials meet the provisions of the Customer Products Stewardship Specification (CSP-9-111C2) and the Banned Substances and Materials of Interest Specification (CSP-9-111S2) and contain no "Banned Substances" as defined in CSP-9-111S2.



**National Semiconductor**  
**Americas Customer**  
**Support Center**  
 Email: [new.feedback@nsc.com](mailto:new.feedback@nsc.com)  
 Tel: 1-800-272-9959

[www.national.com](http://www.national.com)

**National Semiconductor**  
**Europe Customer Support Center**  
 Fax: +49 (0) 180-530 85 86  
 Email: [europe.support@nsc.com](mailto:europe.support@nsc.com)  
 Deutsch Tel: +49 (0) 69 9508 6208  
 English Tel: +44 (0) 870 24 0 2171  
 Français Tel: +33 (0) 1 41 91 8790

**National Semiconductor**  
**Asia Pacific Customer**  
**Support Center**  
 Email: [ap.support@nsc.com](mailto:ap.support@nsc.com)

**National Semiconductor**  
**Japan Customer Support Center**  
 Fax: 81-3-5639-7507  
 Email: [jpn.feedback@nsc.com](mailto:jpn.feedback@nsc.com)  
 Tel: 81-3-5639-7560